

NEA SMART R ROOM CONTROL UNIT D

Installation and operating manual

CONTENT

1	Safety	3
1.1	Used symbols	3
1.2	Intended use	3
1.3	General safety warnings	3
2	Versions	4
2.1	Technical data	4
2.2	Compliance	4
3	Installation	5
3.1	Box contents	5
3.2	Installation	5
4	Operation	7
4.1	Overview and display	7
4.2	Operation	8
4.3	Commissioning (incl. pairing)	8
4.4	Connection test	8
4.5	Comfort programs - Smart Start/Stop mode	8
4.6	Lifestyle functions overview	8
4.7	Lifestyle functions	9
4.8	Overview parameters	9
4.9	Parameters	10
5	Troubleshooting, Cleaning and Decommissioning	11
5.1	Troubleshooting	11
5.2	Changing the batteries	11
5.3	Cleaning	11
5.4	Disposal	11



More information on the Nea Smart control system and all documentation available for download can be found at



www.rehau.com/neasmart

1 SAFETY

1.1 Used symbols



There is danger for life and limb.

1.2 Intended use

The Nea Smart R room control unit D (in the following abbreviated as room control unit D) is a room control unit for the base station Nea Smart R 230 V.

The device is intended

- the control of the Nea Smart R base station 230 V.
- the registration of the room temperature and the setting of the desired target temperature in the allocated heating zone.

Every other use is outside its intended use for which the manufacturer cannot be held liable.

1.3 General safety warnings



Danger to life in case of swallowing

Small children might swallow the knob.

Install room control unit outside the reach of small children.

These instructions belong to the device.

Retain this manual and provide it to future owners.

2 VERSIONS

2.1 Technical data

Nea Smart R room control unit D	
Floor temperature monitoring	Nea Smart remote sensor (optional)
Power supply	2 x LR03/AAA (micro battery) alkaline
Battery lifetime	> 2 years
Wireless technology	Wireless, 868 MHz SRD band
Range	25 m (in buildings)
Protection type/protection class	IP20 / III
Ambient temperature	0 to 50 °C
Ambient humidity	5 to 80%, not condensing
Dimensions (HxWxD)	86 x 86 x 26.5 mm
Target temp. setting range	5 bis 30°C
Target temp. resolution	0.2 K
Actual temp. measuring range	0 bis 40°C (int. sensor)
Measuring accuracy of internal NTC	±0.3 K

Tab. 2-1 Technical data Nea Smart R room control unit D

2.2 Compliance

This product is labelled with the CE Marking and thus is in compliance with the requirements from the guidelines:

- 2004/108/EG with amendments "Council Directive on the approximation of the laws of the Member States relating to Electromagnetic Compatibility"
- 2006/95/EG with amendments "Council for Coordination of the Regulations of EU Member Countries regarding the electrical equipment for use within certain voltage limits"
- "Radio and Telecommunications Terminal Equipment Act (FTEG) and Guideline 1999/5/EG (R&TTE)"

Increased protection requirements may exist for the overall installation, the compliance of which is the responsibility of the installer.

3 INSTALLATION

3.1 Box contents

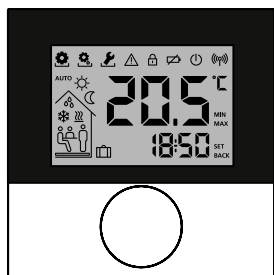

1 x



2 x

Accessories:

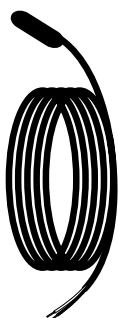

Nea Smart remote sensor

Fig. 3-1 Box contents

3.2 Installation

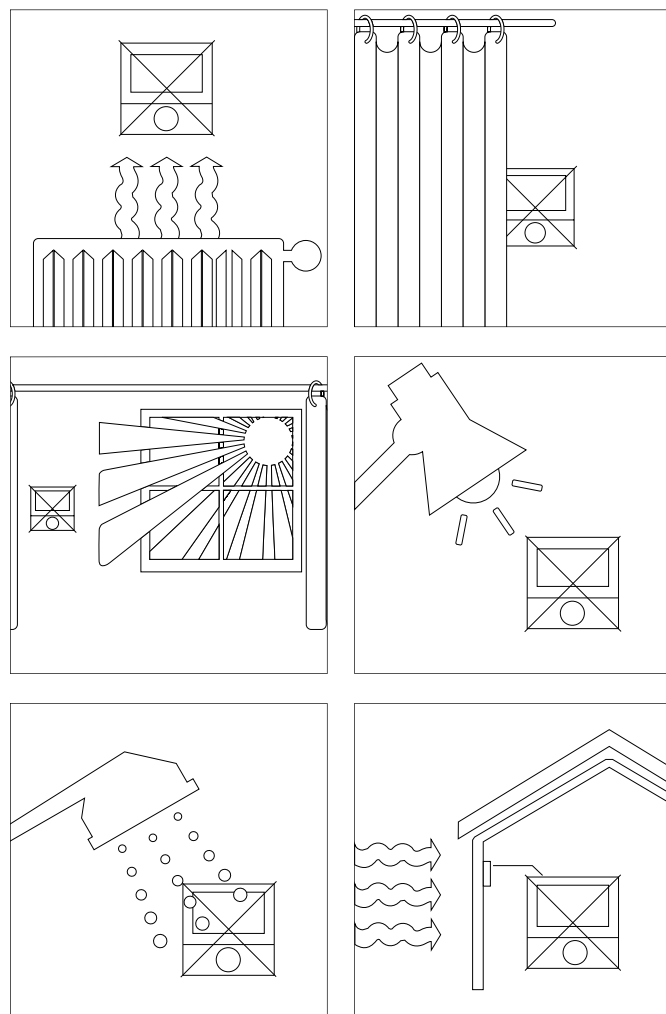
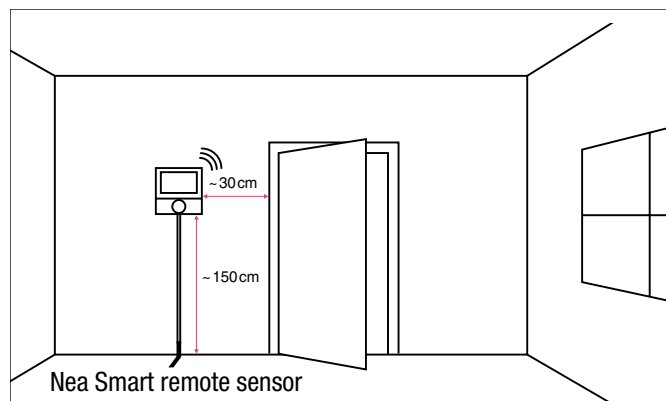

Fig. 3-2 Notes on the mounting location of the room control unit

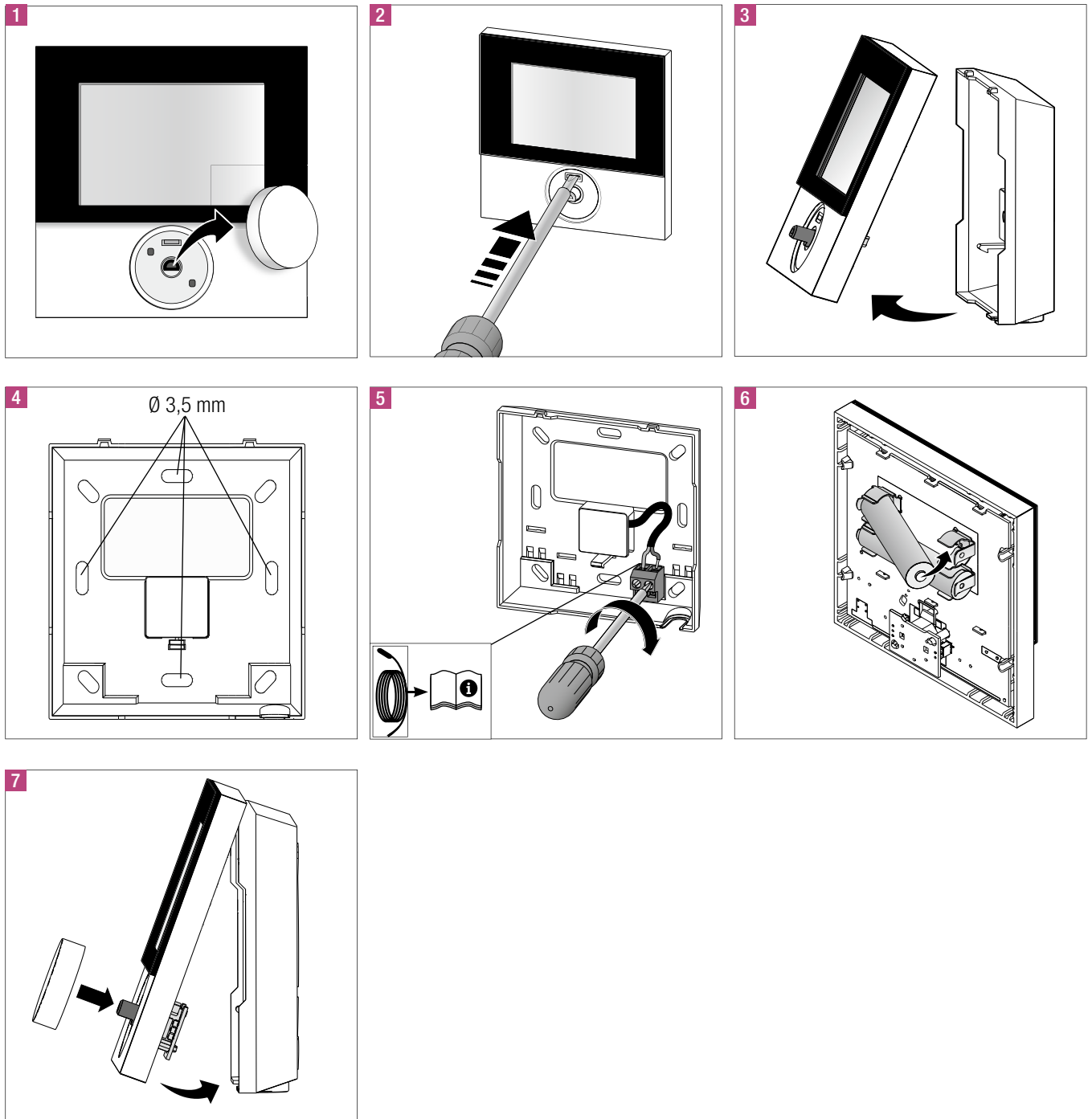

Fig. 3-3 Installation and connection of the room control unit

4 OPERATION

4.1 Overview and display

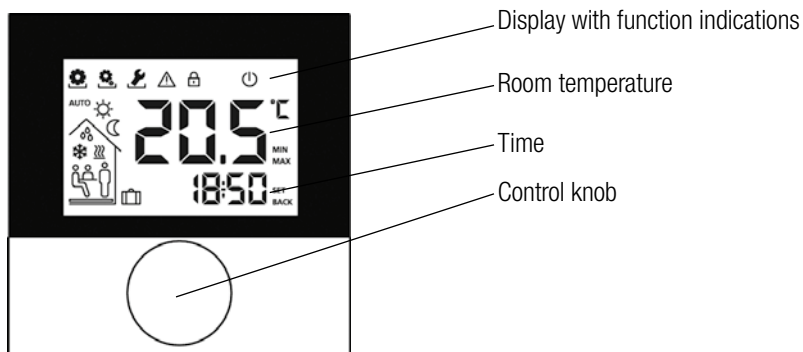

Fig. 4-1 Technical data Nea Smart R room control unit D

Symbol	Meaning
	Menu "Functions" active
	Menu "Parameters" active
	Menu "Service" active
	Important note/malfunction
	Child safety lock active
	Low battery
	Stand-by mode active
	Transmitting power
AUTO	Automatic mode active
	Day mode active

Symbol	Meaning
	Night mode active
	Condensation detected, cooling deactivated
	Cooling mode active
	Flashing: Smart Start/Stop mode active Permanent on: Heating mode active
	Presence active (only in Automatic mode)
	Party function active
	Holiday function Flashing: planned Permanent on: active
	Minimum floor temperature fallen short of

Tab. 4-1 Meaning of display symbols

4.2 Operation

The room control unit can be operated via the control knob:



Pressing the control knob activates menus and functions.



Rotating allows setting the target temperature as well as navigating between menus and functions.

A basic level and three menus are available.

Basic level:



Rotating sets the desired target temperature.

Menu selection with:



Functions: includes all important lifestyle functions.



Parameters: includes several parameters as e. g. heating and setback temperatures, date and many more.



Service: includes settings for the specialist (secured by PIN, see manual of the base station)

4.3 Commissioning (incl. pairing)

1. No other base stations within range must be in pairing mode.
2. Activate the pairing function at the base station for the desired heating zone (see manual base station Nea Smart R 230 V).
3. Press the control knob for approx. 3 s. in order to activate pairing function (the display shows "Set").
 - The base station and the room control unit are connected to each other.
 - If the base station has been programmed before, the date and time of the room control unit are set automatically.

For first commissioning of the base station:

Set year, date and time by rotating, confirm entries by pressing.

4.4 Connection test

Press the control knob for approx. 3 s. in order to activate pairing function (the display shows "Set").

At the base station, the heating zone connected to this room control unit is changed for 1 minute, in other words switched on or off depending on the previous operating status.

4.5 Comfort programs - Smart Start/Stop mode

Comfort programs include pre-defined heating times to be used for working days (1-5) or for the weekend (6-7). Outside the heating times the installation switches to night mode. You can select the comfort programs in the Parameter menu. The Smart Start/Stop Mode of the system calculates the required time delay in order to achieve the desired temperature at the starting and finishing time of the heating program.

Program	Comfort time 1	Comfort time 2
P0	05:30 – 21:00	–
P1	04:30 – 08:30	17:30 – 21:30
P2	06:30 – 10:00	18:00 – 22:00
P3	07:30 – 17:30	–

Tab. 4-2 Predefined time programs

You can create individual comfort programs with the on-line software available under www.ezr-home.de and transfer these to the basis station with a MicroSD card.

4.6 Lifestyle functions overview

In this menu you can activate or deactivate the lifestyle functions.

1. Press the control knob.
2. Activate the menu "Lifestyle functions" by pressing the control knob again.
3. Select the desired lifestyle function.

The following lifestyle functions are available to you; you can find further information in the table "Functions" on the next page.



It may take up to 10 minutes before changes of global lifestyle functions are displayed on all room control units.

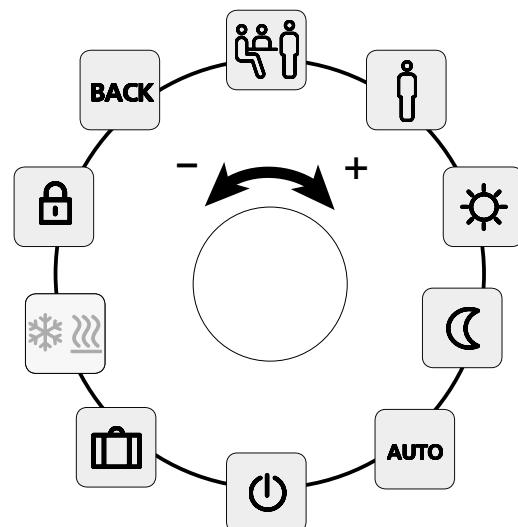

Fig. 4-2 Selection menu of lifestyle-functions

4.7 Lifestyle functions

Lifestyle functions	Symbol	Steps
Party Deactivates the temperature setback for XX hours		- Activate by pressing. - Set the duration in hours (hh) - Confirm your entry by pressing.
Presence Weekend heating times are also used for working days	AUTO 	- The automatic mode is only available on workdays. - Activate by pressing. - Finish by selecting another Lifestyle function.
Day (default setting) Permanent regulation after setting the target temperature		- Activate by pressing.
Night Permanent setback to a programmed night temperature.		- Activate by pressing.
Automatic Automatic temperature regulation according to the correspondingly activated comfort programs	AUTO	- Activate by pressing.
Deactivates the room control unit, the temperature is still displayed, frost protection is activated		- Press in order to switch off the room control unit - A short press switches the room control unit on again
Selection of heating or cooling operation The operating mode can be set on the room control unit D when the CO pilot function is activated on the base.		(The CO pilot of the base is activated.) - Activate by pressing. - Select the mode. - Confirm your entry by pressing.
Holiday mode The temperature is set back automatically to the set holiday temperature		- Activate by pressing. - Select 1. the start date and 2. the end date (dd:mm) confirm by pressing. - Deactivate the holiday mode by calling the function again.
Child safety lock Locks the room operating unit		- Activate by pressing. - Deactivate by prolonged pressing (>3 s).
BACK The room control unit returns to the basic level.	BACK	- Exit the menu by pressing

Tab. 4-3 Lifestyle functions

4.8 Overview parameters

This menu is needed only for basic setup.

- Press the control knob.
- Select the menu "Parameters" and activate it by pressing again.

The following parameters are available to you; you can find further information in the table "Parameters" on the next page.

It may take up to 10 minutes before changes of global system parameters are displayed on all room control units.

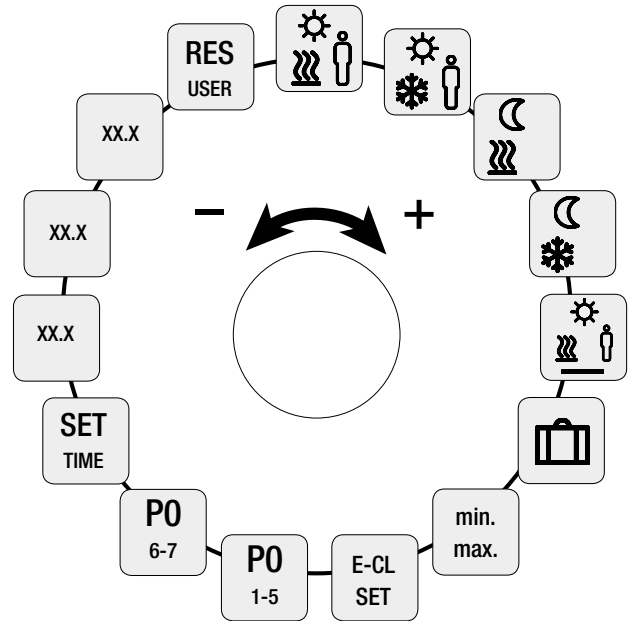



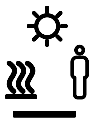



Fig. 4-3 Selection of parameters

4.9 Parameters

Parameters	Symbol	Steps
Temperature for presence in heating mode		- Activate and set the desired temperature. - Confirm by pressing.
Temperature for presence in cooling mode		- Activate and set the desired temperature. - Confirm by pressing.
Setback temperature for heating mode		- Activate and set the desired temperature. - Confirm by pressing.
Setback temperature for cooling mode		- Activate and set the desired temperature. - Confirm by pressing.
Floor heating minimum temperature (only in connection with Nea remote sensor)		- Activate and select the desired comfort temperature (1.0...6.0 ≈ 18 °C...28 °C) - Confirm by pressing.
Setback temperature for holidays		- Activate and set the desired temperature. - Confirm by pressing.
Setting the temperature limitation	min max	- Activate - Select the min./max. settable temperature, confirm each by pressing
Time control via external timer (instead of integrated programs P0 to P3)	E-CL SET	- Activate and select the status On or Off. - Confirm by pressing.
Select Comfort program for working days	P0 1-5	- Activate and confirm entry. - Select and activate lifestyle program (P0-P3).
Select Comfort program for the weekend	P0 6-7	- Activate and confirm entry. - Select and activate lifestyle program (P0-P3).
Set time/date	SET TIME	- Activate, set year (yyyy), month (mm) and day (dd) as well as time (hh:mm), confirm each by pressing.
Info software version of room control unit	So1 XX-XX	- Display of the room control unit software version

Parameters	Symbol	Steps
Info base station software version	So2 XX-XX	- Display of the base station software version
Info software version Ethernet Controller	So3 XX-XX	- Display of the software version of the Ethernet Controller
User level reset Reset of all user settings to factory settings!	RES USER	- Activate and select Yes - Press in order to reset all functions.

Tab. 4-4 Parameters

5 TROUBLESHOOTING, CLEANING AND DECOMMISSIONING

5.1 Troubleshooting

For error signalling purposes, the corresponding symbols in the display flash.

Display	Meaning	Handling
	Low battery	- Battery replacement will soon be necessary.
	Connection to base station faulty	- Check the voltage supply of the base station. - Use the repeater accessories or active antennae for a greater wireless range. - Contact your electric installer in case of a defect.
20.5 °C ----	Room control unit not paired.	- Carry out new pairing of the room control unit. - Contact your electric installer.
	Base station switched off	- Re-establish the power supply to the base station. - Contact your electric installer in case of a defect.
 Err 0001	Internal temperature sensor defective.	- The room control unit must be replaced.
 Err 0002	External temperature sensor defective.	- Replacement necessary, contact your electric installer.
 Err 0004	Very low battery	- Change the batteries immediately.
 Err 0005	Base station not found in spite of successful pairing	- Check the voltage supply of the base station. - Perform another pairing of the room control unit. - Contact your electric installer.
 Err 0006	Communication between base stations faulty	- Check the voltage supply of the base station. - Contact your electric installer.

Tab. 5-1 Errors shown on the display

5.2 Changing the batteries

Danger to life in case of swallowing
Small children can swallow batteries/rotating knobs. Do not leave the room control unit unattended during a battery change.

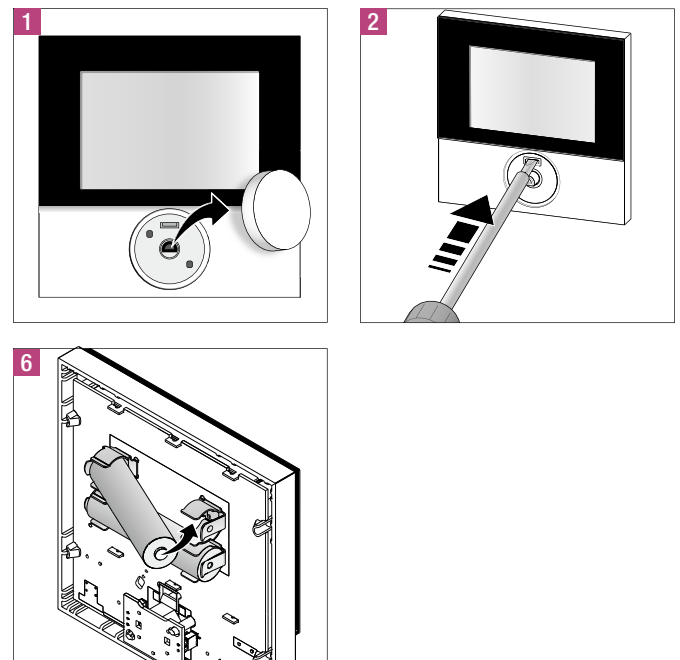

Fig. 5-1 Changing the batteries

Activate the room control unit by pressing.
All previously made settings will be recovered.

5.3 Cleaning

Only use a dry and solvent-free, soft cloth for cleaning.

5.4 Disposal

The batteries and the room control unit must not be disposed with domestic waste. The operator has the duty to hand the devices to appropriate collection points. The separate collection and orderly disposal of all materials will help to conserve natural resources and ensure a recycling in a manner that protects human health and the environment. If you need information about collection points for your devices, please contact your local municipality or your local waste disposal services.

This document is protected by copyright. All rights based on this are reserved. No part of this publication may be translated, reproduced or transmitted in any form or by any similar means, electronic or mechanical, photocopying, recording or otherwise, or stored in a data retrieval system.

Insofar as the intended application deviates from that described in the relevant Technical Information brochure, the user must consult REHAU and must receive express written consent from REHAU before commencing this utilization. If the user fails to do so, the sole responsibility for the utilization shall lie with the individual user. In this case, the application, use and processing of products are beyond our control. Should a case of liability arise, however, this shall be limited to the value of the goods delivered by us and used by you in all cases of damage. Claims arising from granted guarantees shall become invalid in the case of intended applications that are not described in the Technical Information brochures.

REHAU SALES OFFICES

AE: Middle East, +971 4 8835677, dubai@rehaus.com **AR: Buenos Aires**, +54 11 48986000, buenosaires@rehaus.com **AT: Linz**, +43 732 3816100, linz@rehaus.com **Wien**, +43 2236 24684, wien@rehaus.com **Graz**, +43 361 403049, graz@rehaus.com **AU: Adelaide**, +61 8 82990031, adelaide@rehaus.com **Brisbane**, +61 7 55271833, brisbane@rehaus.com **Melbourne**, +61 3 95875544, melbourne@rehaus.com **Perth**, +61 8 94564311, perth@rehaus.com **Sydney**, +61 2 87414500, sydney@rehaus.com **AZ: Baku**, +99 412 5110792, baku@rehaus.com **BA: Sarajevo**, +387 33 475500, sarajevo@rehaus.com **BE: Bruxelles**, +32 16 399911, bruxelles@rehaus.com **BG: Sofia**, +359 2 8920471, sofia@rehaus.com **BR: Arapongas**, +55 43 31522004, arapongas@rehaus.com **Belo Horizonte**, +55 31 33097737, belo Horizonte@rehaus.com **Caxias do Sul**, +55 54 32146606, caxias@rehaus.com **Mirassol**, +55 17 32535190, mirassol@rehaus.com **Recife**, +55 81 32028100, recife@rehaus.com **BY: Minsk**, +375 17 2450209, minsk@rehaus.com **CA: Moncton**, +1 506 5382346, moncton@rehaus.com **Montreal**, +1 514 9050345, montreal@rehaus.com **St. John's**, +1 709 7473909, stjohns@rehaus.com **Toronto**, +1 905 3353284, toronto@rehaus.com **Vancouver**, +1 604 6264666, vancouver@rehaus.com **CH: Bern**, +41 31 720120, bern@rehaus.com **Vevey**, +41 21 9482636, vevey@rehaus.com **Zuerich**, +41 44 8397979, zuerich@rehaus.com **CN: Guangzhou**, +86 20 87760343, guangzhou@rehaus.com **Beijing**, +86 10 64282956, beijing@rehaus.com **Shanghai**, +86 21 63551155, shanghai@rehaus.com **Chengdu**, +86 28 86283218, chengdu@rehaus.com **Xian**, +86 29 68597000, xian@rehaus.com **Shenyang**, +86 24 22876807, shenyang@rehaus.com **Qingdao**, +86 32 86678190, qingdao@rehaus.com **CO: Bogota**, +57 1 898 528687, bogota@rehaus.com **CZ: Praha**, +420 272 190111, praha@rehaus.com **DE: Berlin**, +49 30 667660, berlin@rehaus.com **Bielefeld**, +49 521 208400, bielefeld@rehaus.com **Bochum**, +49 234 689030, bochum@rehaus.com **Frankfurt**, +49 6074 40900, frankfurt@rehaus.com **Hamburg**, +49 40 733402100, hamburg@rehaus.com **Hannover**, +49 5136 891181, hannover@rehaus.com **Leipzig**, +49 34292 820, leipzig@rehaus.com **München**, +49 8102 860, muenchen@rehaus.com **Nürnberg**, +49 9131 934080, nuernberg@rehaus.com **Stuttgart**, +49 7159 16010, stuttgart@rehaus.com **Ingolstadt**, +49 841 142626200, ingolstadt@rehaus.com **DK: København**, +45 46 773700, københavn@rehaus.com **EE: Tallinn**, +372 6025850, tallinn@rehaus.com **ES: Barcelona**, +34 93 6353500, barcelona@rehaus.com **Bilbao**, +34 94 4538636, bilbao@rehaus.com **Madrid**, +34 91 6839425, madrid@rehaus.com **Fi: Helsinki**, +358 9 87709900, helsinki@rehaus.com **FR: Lyon**, +33 4 72026300, lyon@rehaus.com **Metz**, +33 6 8500, metz@rehaus.com **Paris**, +33 1 34836450, paris@rehaus.com **GB: Glasgow**, +44 1698 503700, glasgow@rehaus.com **Manchester**, +44 161 7777400, manchester@rehaus.com **Slough**, +44 1753 588500, slough@rehaus.com **Ross on Wye**, +44 1989 762643, rowy@rehaus.com **London**, +44 207 3078590, london@rehaus.com **GE: Tbilisi**, +995 32 559909, tbilisi@rehaus.com **GR: Athens**, +30 21 06682500, athens@rehaus.com **Thessaloniki**, +30 2310 633301, thessaloniki@rehaus.com **HK: Hongkong**, +8 52 28987080, hongkong@rehaus.com **HR: Zagreb**, +385 1 3444711, zagreb@rehaus.com **HU: Budapest**, +36 23 530700, budapest@rehaus.com **ID: Jakarta**, +62 21 45871030, jakarta@rehaus.com **IE: Dublin**, +353 1 8165020, dublin@rehaus.com **IN: Mumbai**, +91 22 61485858, mumbai@rehaus.com **New Delhi**, +91 11 45044700, newdelhi@rehaus.com **Bangalore**, +91 80 2222001314, bangalore@rehaus.com **IT: Pesaro**, +39 0721 200611, pesaro@rehaus.com **Roma**, +39 06 90061311, roma@rehaus.com **Treviso**, +39 0422 726511, treviso@rehaus.com **JP: Tokyo**, +81 3 57962102, tokyo@rehaus.com **KR: Seoul**, +82 2 50116566, seoul@rehaus.com **KZ: Almaty**, +7 727 3941301, almaty@rehaus.com **LT: Vilnius**, +370 5 2461400, vilnius@rehaus.com **LV: Riga**, +371 6 7609080, riga@rehaus.com **MA: Casablanca**, +212 522250593, casablanca@rehaus.com **MK: Skopje**, +389 2 2402, skopje@rehaus.com **MX: Celaya**, +52 461 6188000, celaya@rehaus.com **Monterrey**, +52 81 81210130, monterrey@rehaus.com **NL: Nijkerk**, +31 33 2479911, nijkerk@rehaus.com **NO: Oslo**, +47 2 2514150, oslo@rehaus.com **NZ: Auckland**, +64 9 2722264, auckland@rehaus.com **PE: Lima**, +51 1 2261713, lima@rehaus.com **PL: Katowice**, +48 32 7755100, katowice@rehaus.com **Warszawa**, +48 22 2056300, warszawa@rehaus.com **PT: Lisboa**, +351 21 8987050, lisboa@rehaus.com **Oporto**, +351 22 94464, oporto@rehaus.com **QA: Qatar**, +974 44101608, qatar@rehaus.com **RO: Bacau**, +40 234 512066, bacau@rehaus.com **Bucuresti**, +40 21 2665180, bucaresti@rehaus.com **Cluj Napoca**, +40 264 415211, clujnapoca@rehaus.com **RS: Beograd**, +381 11 3770301, beograd@rehaus.com **RU: Chabarowsk**, +7 4212 411218, chabarowsk@rehaus.com **Jekaterinburg**, +7 343 2535305, jekatarinburg@rehaus.com **Krasnodar**, +7 861 2103636, krasnodar@rehaus.com **Nishnij Nowgorod**, +7 831 4678078, nishnijnowgorod@rehaus.com **Novosibirsk**, +7 3832 000353, novosibirsk@rehaus.com **Rostow am Don**, +7 8632 978444, rostow@rehaus.com **Samara**, +7 8462 698058, samara@rehaus.com **St. Petersburg**, +7 812 3266207, stpetersburg@rehaus.com **Woronesch**, +7 4732 611858, woronesch@rehaus.com **SE: Orebro**, +46 19 206400, oerebro@rehaus.com **SG: Singapore**, +65 63926006, singapore@rehaus.com **SK: Bratislava**, +421 2 68209110, bratislava@rehaus.com **TH: Bangkok**, +66 27635100, bangkok@rehaus.com **TW: Taipei**, +886 2 87803899, taipei@rehaus.com **UA: Dnepropetrowsk**, +380 56 3705028, dnepropetrowsk@rehaus.com **Kiev**, +380 44 4677710, kiev@rehaus.com **Odessa**, +380 48 7800708, odessa@rehaus.com **Lviv**, +380 32 2244810, liviv@rehaus.com **US: Detroit**, +1 248 8489100, detroit@rehaus.com **Grand Rapids**, +1 616 2856867, grandrapids@rehaus.com **Los Angeles**, +1 951 5499017, losangeles@rehaus.com **Minneapolis**, +1 612 2530576, minneapolis@rehaus.com **VN: Ho Chi Minh City**, +84 8 38233030, sales.vietnam@rehaus.com **ZA: Durban**, +27 31 7657447, durban@rehaus.com **Johannesburg**, +27 11 2011300, johannesburg@rehaus.com **Cape Town**, +27 21 9821254, capetown@rehaus.com **East London**, +27 43 7095400, eastlondon@rehaus.com **If there is no sales office in your country**, +49 9131 925888, salesoffice.ibd@rehaus.com

© REHAU AG + Co
Rheniumhaus
95111 Rehaus
Subject to technical changes.

954624 DE 04.2015